

# ***FITNESS360***<sup>®</sup>

FT3344

Ribbe i stål

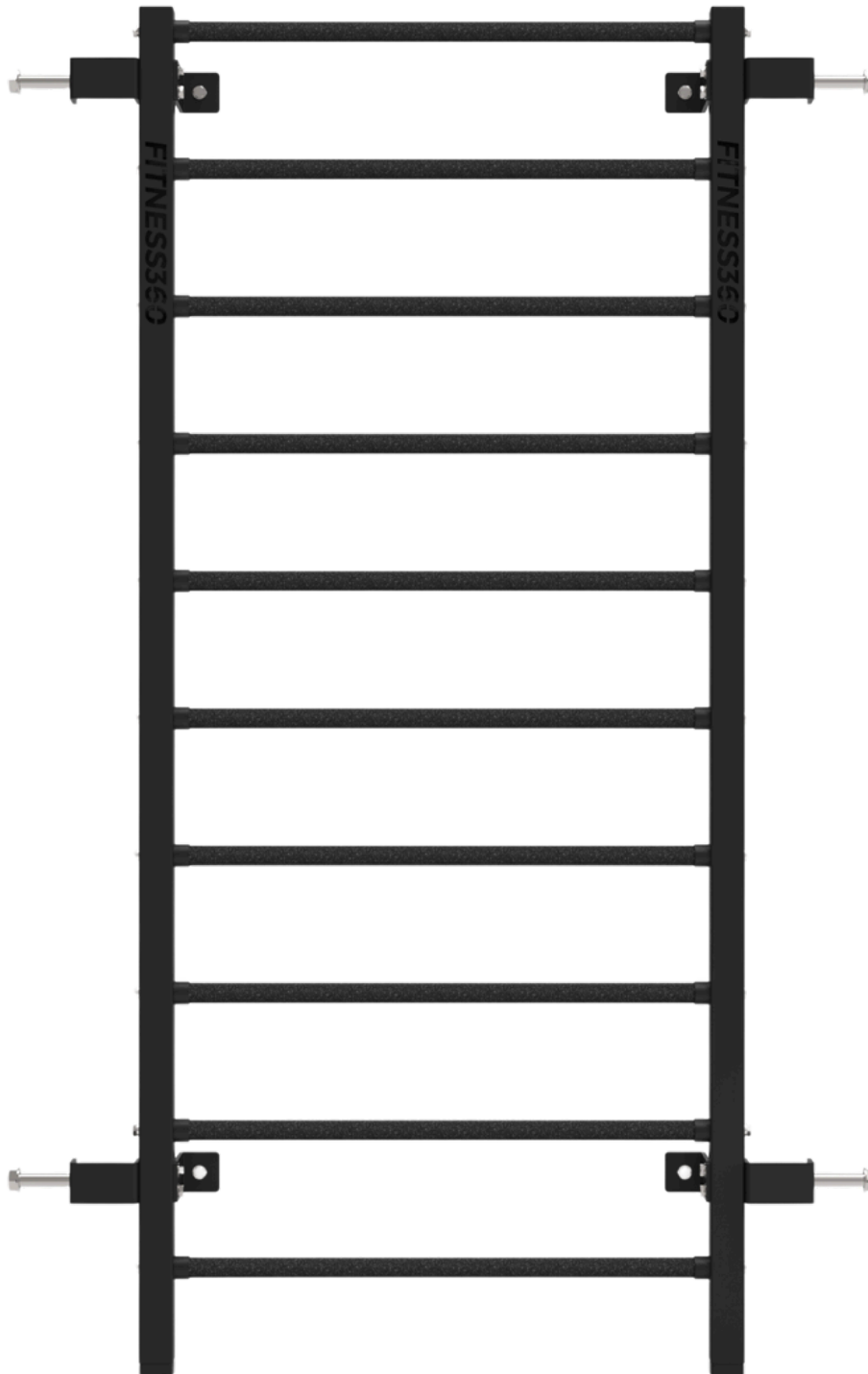

# SAFETY PRECAUTION

Before using your equipment, please take a few moments to read these safety instructions carefully. Following these guidelines will help reduce the risk of injury and ensure safe, long-lasting use of your equipment.

## **a. Assembly**

- Assemble the equipment according to the instructions provided.
- Only use the supplied parts intended specifically for this product.
- Before assembly, check that all components listed in the parts list are included

## **b. Read the Manual**

- Read and understand this Owner's Manual before using the equipment.
- Familiarize yourself with all warning labels and recommended operating procedures.
- If you are unsure about proper use, consult your retailer or a qualified fitness professional.

## **c. Keep Documentation and Labels Intact**

Retain this Owner's Manual for future reference and ensure all warning labels remain legible and intact. Replacement manuals and labels are available from your retailer.

## **d. Assistance During Assembly**

- We recommend that two people assemble this equipment.

## **e. Consult a Physician**

Consult your physician before beginning any exercise program, particularly if you have any medical conditions or concerns.

## **f. Children and Safety**

Never allow children to use or play around the equipment without adult supervision.

## **g. Inspect Cables Regularly**

- Regularly inspect cables for signs of wear or damage.
- Do not use the equipment if any cable is frayed or damaged.

## **h. Keep Clear of Moving Parts**

Keep hands, limbs, loose clothing, jewelry, and long hair away from moving parts.

## **i. Use Appropriate Weight Loads**

Do not attempt to lift more weight than you can safely control.

## **j. Exercise Responsibly**

Train within your recommended fitness level. Do not exercise to exhaustion. Stop immediately if you experience pain, dizziness, or discomfort.

## **k. Inspect Equipment Before Use**

Check the machine regularly for loose hardware, worn parts, cracks, or other damage. Do not use the equipment until defective parts have been repaired or replaced.

## **l. Keep Sharp Objects Away**

Do not place sharp objects around or near the machine.

## **m. Maximum User Weight**

Maximum user weight: 120 kg.

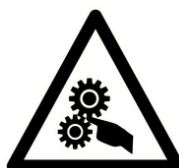

# ASSEMBLY INSTRUCTION

## I. Assembly Notes

Before assembling your equipment, please read these instructions carefully.

- Ensure you have sufficient space to assemble and safely operate the equipment.
- To protect your flooring, assemble the machine on a protective surface such as cardboard or a floor mat.
- The nuts and bolts are lightly coated with grease to prevent corrosion. Keep a cloth nearby to wipe your hands if necessary.
- Plastic end caps and plugs are pre-installed before shipment. They are shown in the assembly drawings for reference should replacement parts be required.
- This equipment uses bolts of various lengths. Always ensure you use the correct bolt specified for each assembly step.
- If drilling into walls or floors is required, ensure that no electrical wires, water pipes, or other concealed services are located behind the drilling area.

## II. Before You Begin

- Choose a spacious, well-lit, and well-ventilated area for assembly.
- We recommend assembling the equipment with the assistance of another person, as some components may be heavy or difficult to handle alone.
- Ensure the machine is placed in a location that provides sufficient clearance for safe use and maintenance.











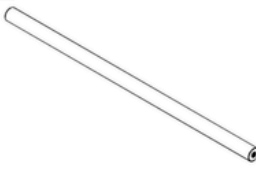
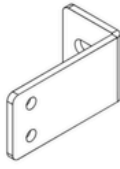
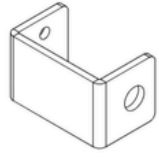

### Tools Required

- Standard screwdriver
- WD-40® lubricant or petroleum jelly (if required)

## III. Assembling Your Machine

Follow the step-by-step assembly guide on the following pages. Ensure all bolts are fully tightened before using the equipment.

# PART LIST

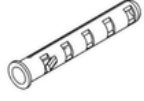
<p>1</p>  <p>1 PC</p>	<p>2</p>  <p>1 PC</p>	<p>3</p>  <p>10 PC</p>	<p>4</p>  <p>4 PC</p>
<p>5</p>  <p>4 PC</p>	<p>6</p> <p>M10 Washer</p>  <p>32 PC</p>	<p>7</p> <p>M10 Spring Washer</p>  <p>20 PC</p>	<p>8</p> <p>M10 Big Washer</p>  <p>8 PC</p>
<p>9</p> <p>M20 Washer</p>  <p>8 PC</p>	<p>10</p> <p>M10 Nut</p>  <p>8 PC</p>	<p>11</p> <p>M20 Nut</p>  <p>4 PC</p>	<p>12</p> <p>M10*20 Bolt</p>  <p>20 PC</p>
<p>13</p> <p>M10*75 Bolt</p>  <p>8 PC</p>	<p>14</p> <p>M10*80 Bolt</p>  <p>4 PC</p>	<p>15</p> <p>M20*110 Bolt</p>  <p>4 PC</p>	<p>16</p>  <p>4 PC</p>

# STEP 1

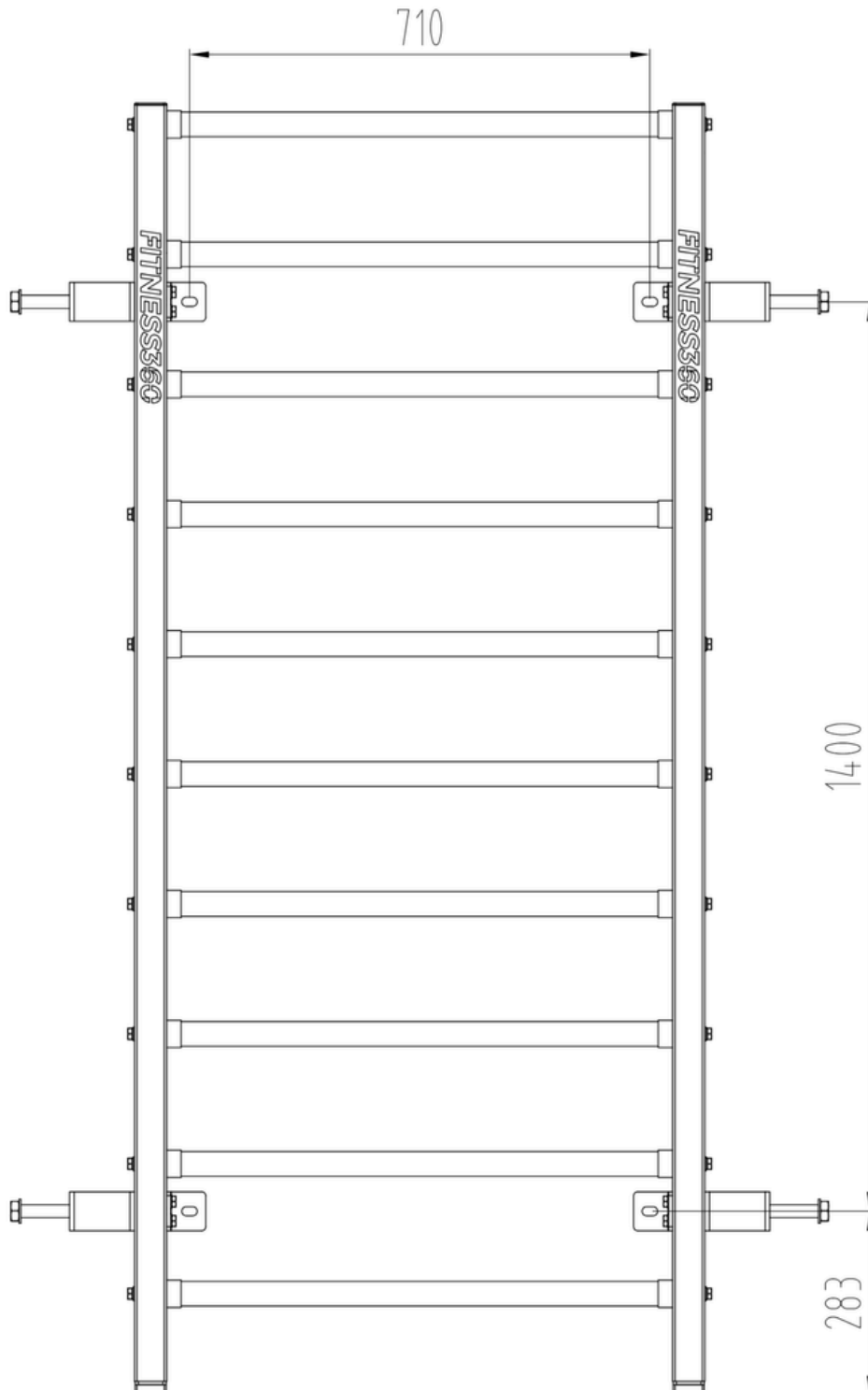
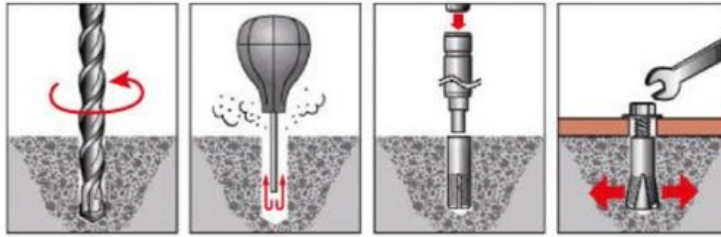

# STEP 2

