

# ***FITNESS360***<sup>®</sup>

## **FT3068-U**

### **Udendørs Justerbar Træningsbænk**



# SAFETY PRECAUTION

Regardless of how enthusiastic you may be about using this equipment and exercising, always take the necessary precautions to ensure your safety is not compromised. A moment of inattention or failure to follow basic safety guidelines may result in serious injury.

## **a. Assembly**

Assemble the equipment according to the instructions provided. Only use the supplied parts intended for this equipment. Before assembly, check that all parts have been delivered and are undamaged.

## **b. Read the Manual**

Read and understand the Owner's Manual and all warning labels before use. Ensure all users are familiar with the proper operation of the equipment.

## **c. Keep Documentation and Labels Intact**

Retain this Owner's Manual for future reference and ensure all warning labels remain legible and intact. Replacement manuals and labels are available from your retailer.

## **d. Assistance During Assembly**

It is recommended that another person assist with the assembly of this unit.

## **e. Consult a Physician**

Consult your physician before beginning any exercise program. A physical examination is recommended prior to use.

## **f. Children and Safety**

Use caution when children are present near the equipment.

## **g. Inspect Cables Regularly**

Frayed or worn cables may cause injury. Regularly inspect cables and moving parts for signs of wear or damage.

## **h. Keep Clear of Moving Parts**

Keep hands, limbs, loose clothing, jewelry, and long hair away from moving parts.

## **i. Use Appropriate Weight Loads**

Do not attempt to lift more weight than you can safely control.

## **j. Exercise Responsibly**

Train within your recommended fitness level. Do not exercise to exhaustion. Stop immediately if you experience pain, dizziness, or discomfort.

## **k. Inspect Equipment Before Use**

Check the machine regularly for loose hardware, worn parts, cracks, or other damage. Do not use the equipment until defective parts have been repaired or replaced.

## **l. Keep Sharp Objects Away**

Do not place sharp objects around or near the machine.

## **m. Maximum User Weight**

Maximum user weight: 120 kg.

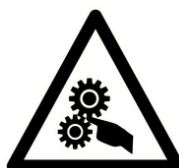

# ASSEMBLY INSTRUCTION

## I. Assembly Notes

- Ensure sufficient space is available to safely assemble and properly use the machine.
- To protect your flooring during assembly, use floor padding such as cardboard or a protective mat.
- Nuts and bolts may be lightly greased to prevent corrosion. Keep a cloth nearby to clean your hands if necessary.
- All plastic caps and plugs are pre-installed before shipment. They are shown in the assembly drawings for reference should replacement parts be required.
- The machine uses bolts of various lengths. Carefully ensure the correct bolt is used at each assembly step.
- Take care not to damage wires or cables during assembly or drilling.

## II. Before You Begin

- Choose a comfortable and well-ventilated workspace with adequate lighting. It is recommended that assembly is completed with the assistance of another person. Due to the size of the machine, ensure sufficient surrounding space during installation.
- Before starting assembly, prepare the following tools:
  - Standard screwdriver
  - WD-40 lubricant or Vaseline (if necessary)

## III. Assembling Your Machine



# PART LIST

NO.	DESCRIPT	QTY
A	MAIN FRAME	1
B	BACK FOOT	1
C	POSTERIOR DENTAL PLATE	1
D	ANTERIOR DENTAL PLATE	1
E	BACK SUPPORT	1
F	FRON SUPPORT	1
G	AXL	2
H	CUSHI N PLATE	1
I	FRONT SEAT PLATE REAR	2
J	SE T	1
K	CUSHION	1
		1
		1

NO.	DESCRIPT	QTY
1	WASHER 10	12
2	WASHER 12	20
3	WASHER 16	4
4	LOCK NUT M12	11
5	LOCK NUT M16	2
6	HEXAGONAL SCREW M10*16	2
7	HEXAGONAL SCREW M10*30	10
8	HEXAGONAL SCREW M12*105	5
9	HEXAGONAL SCREW M12*135	2
10	HEXAGONAL SCREW M12*160	1
11	HEXAGONAL SCREW M12*175	1
12	HEXAGONAL SCREW M16*110	2
13	DOUBLE HEAD SCREWM12*178	1

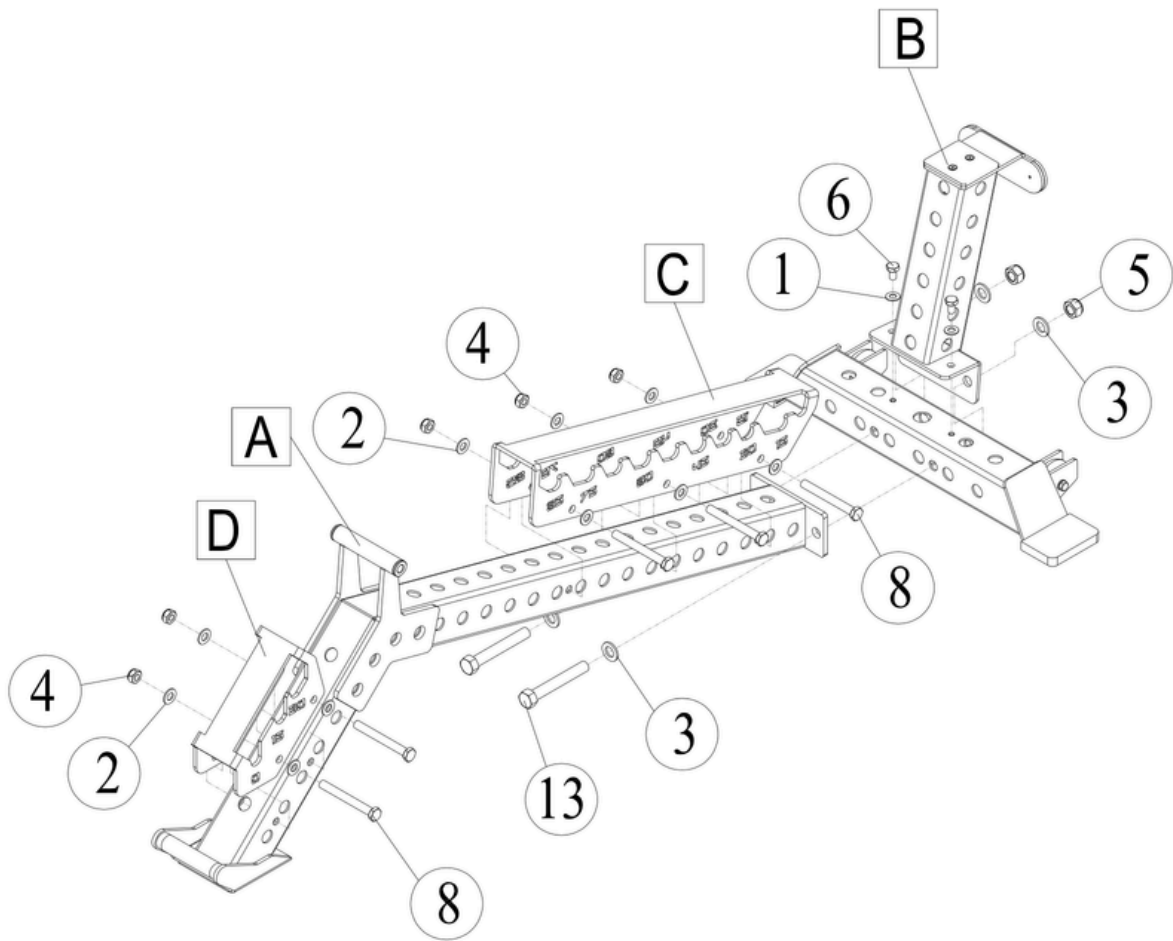
# STEP 1







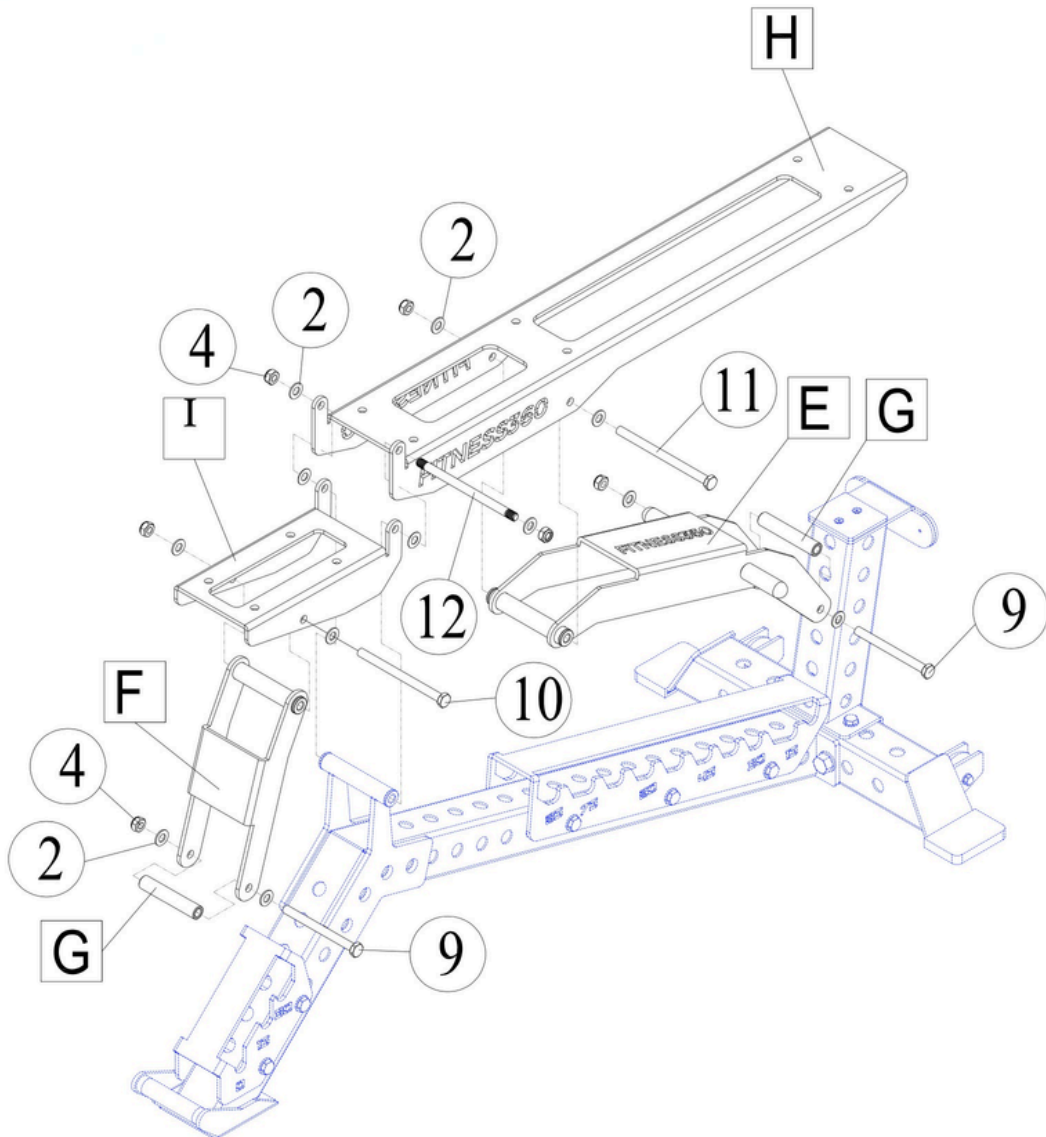

1		M10*16	Qty:2
8		M12*105	Qty:5
13		M16*110	Qty:2

1		10	Qty:2
2		12	Qty:10
3		16	Qty:4
4		12	Qty:5
5		M16	Qty:2

## STEP 2



9		M12*135	Qty:2
10		M12*160	Qty:1
11		M12*175	Qty:1
12		M12*190	Qty:1

2		12	Qty:10
4		M12	Qty:6

# STEP 3

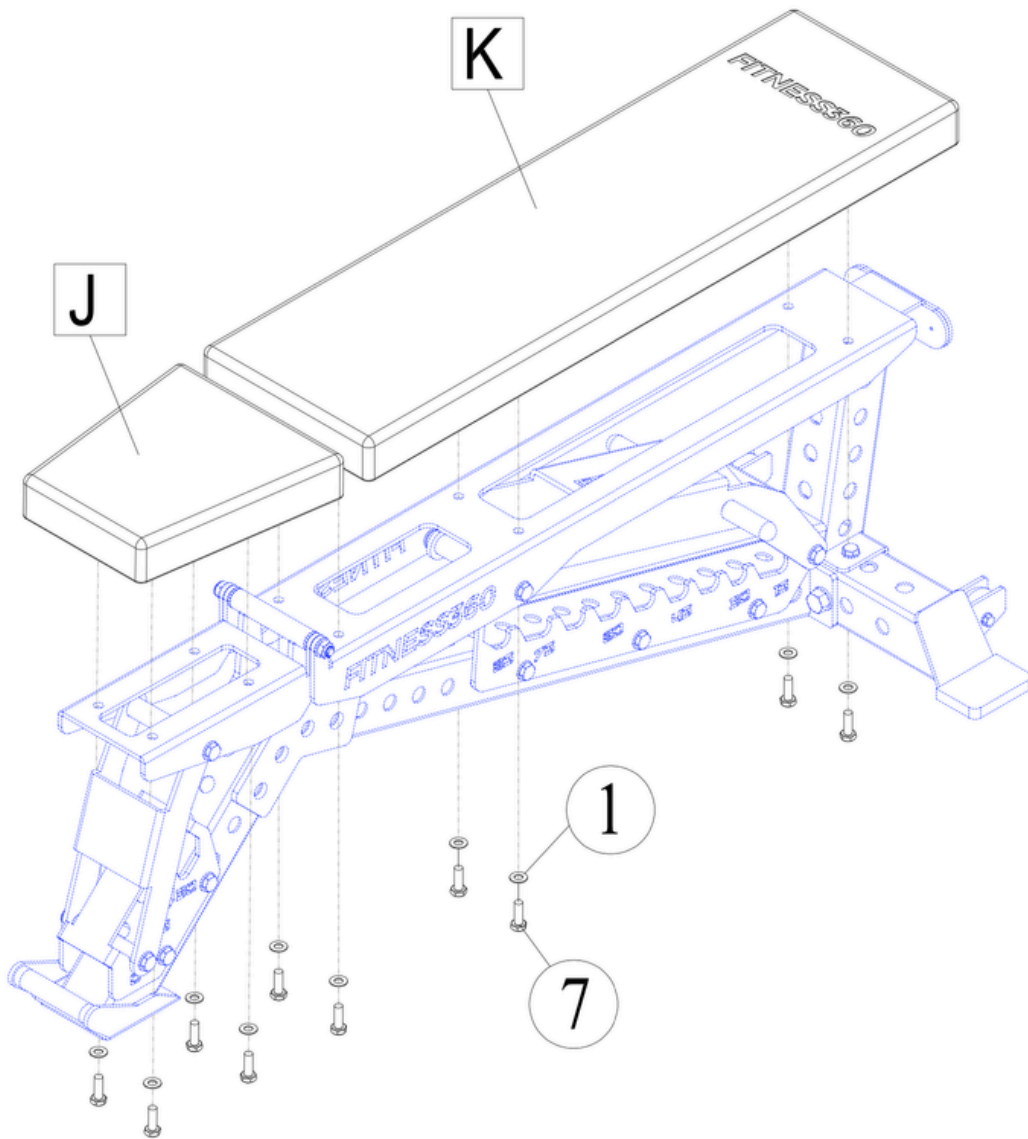

1		M10*30	Qty:10	7		10	Qty:10
---	---	--------	--------	---	--	----	--------