

FITNESS360[®]

FT3083

Justerbar Mavebænk – Pro



SAFETY PRECAUTION

Regardless of how enthusiastic you may be about using this equipment and exercising, always take the necessary precautions to ensure your safety is not compromised. A moment of inattention or failure to follow basic safety guidelines may result in serious injury.

a. Assembly

Assemble the equipment according to the instructions provided. Only use the supplied parts intended for this equipment. Before assembly, check that all parts have been delivered and are undamaged.

b. Read the Manual

Read and understand the Owner's Manual and all warning labels before use. Ensure all users are familiar with the proper operation of the equipment.

c. Keep Documentation and Labels Intact

Retain this Owner's Manual for future reference and ensure all warning labels remain legible and intact. Replacement manuals and labels are available from your retailer.

d. Assistance During Assembly

It is recommended that another person assist with the assembly of this unit.

e. Consult a Physician

Consult your physician before beginning any exercise program. A physical examination is recommended prior to use.

f. Children and Safety

Use caution when children are present near the equipment.

g. Inspect Cables Regularly

Frayed or worn cables may cause injury. Regularly inspect cables and moving parts for signs of wear or damage.

h. Keep Clear of Moving Parts

Keep hands, limbs, loose clothing, jewelry, and long hair away from moving parts.

i. Use Appropriate Weight Loads

Do not attempt to lift more weight than you can safely control.

j. Exercise Responsibly

Train within your recommended fitness level. Do not exercise to exhaustion. Stop immediately if you experience pain, dizziness, or discomfort.

k. Inspect Equipment Before Use

Check the machine regularly for loose hardware, worn parts, cracks, or other damage. Do not use the equipment until defective parts have been repaired or replaced.

l. Keep Sharp Objects Away

Do not place sharp objects around or near the machine.

m. Maximum User Weight

Maximum user weight: 120 kg.



d



f

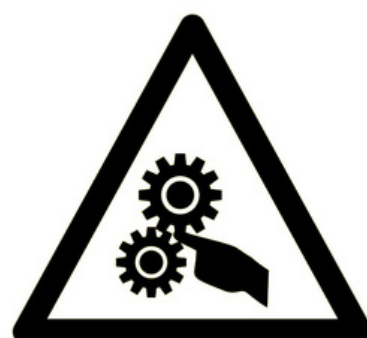

h



i

ASSEMBLY INSTRUCTION

I. Assembly Notes

- Ensure you have sufficient space to properly assemble and use the machine.
- Use floor protection such as cardboard or a mat during assembly to avoid scratching the floor.
- Nuts and bolts may be lightly greased to protect against corrosion. Keep a cloth nearby to wipe your hands if needed.
- Plastic caps and plugs are pre-installed before shipment and are shown in the assembly drawings for reference if replacements are required.
- The machine uses bolts of different lengths. Carefully ensure the correct bolt is used for each assembly step.
- Avoid damaging wires and cables during assembly or drilling.

II. Before You Begin

- Choose a comfortable and well-ventilated workspace with adequate lighting. It is recommended that assembly is completed with the assistance of another person. Due to the size of the machine, ensure sufficient surrounding space during installation.
- Before starting assembly, prepare the following tools:
 - Standard screwdriver
 - WD-40 lubricant or Vaseline (if necessary)

III. Assembling Your Machine

PART LIST

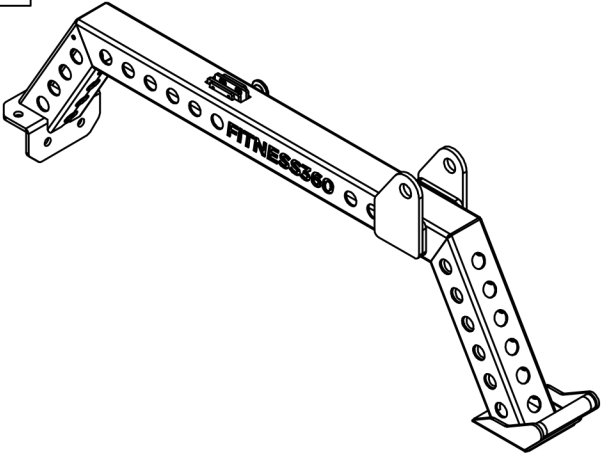
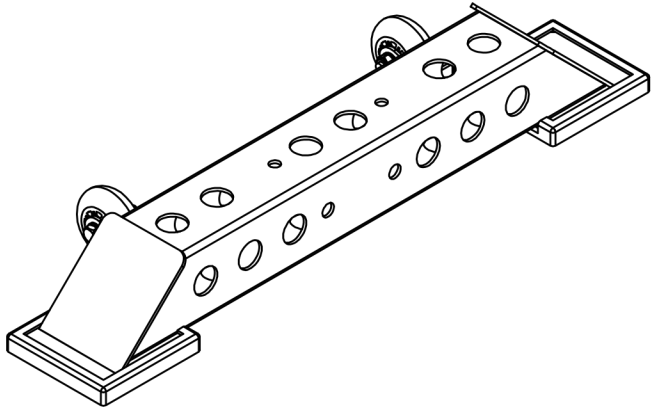
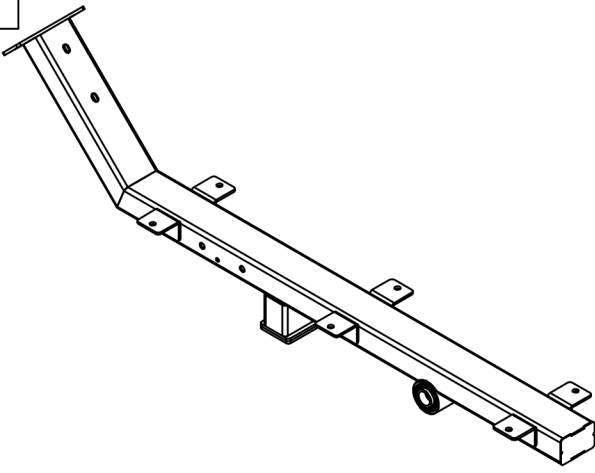
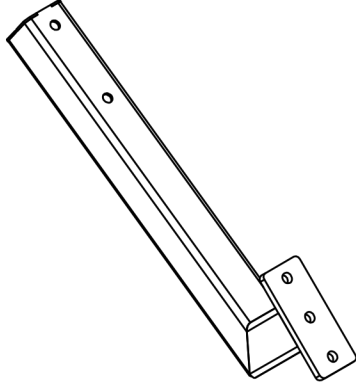
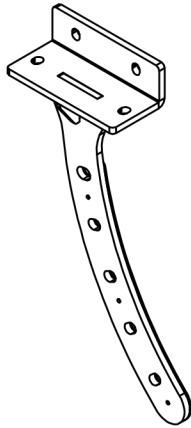
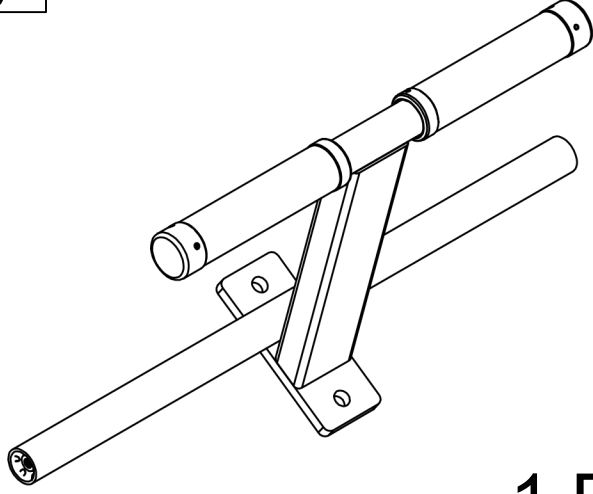
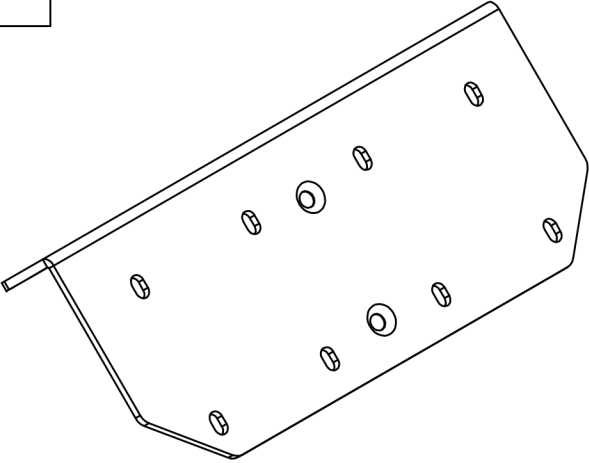
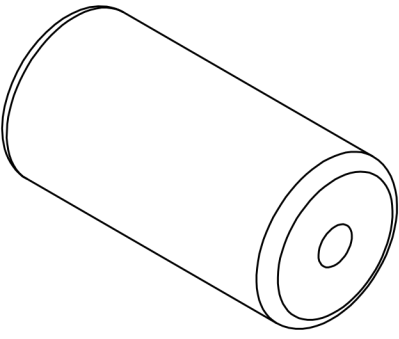
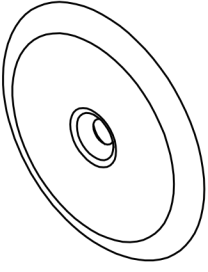
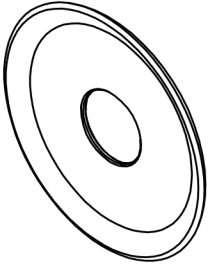
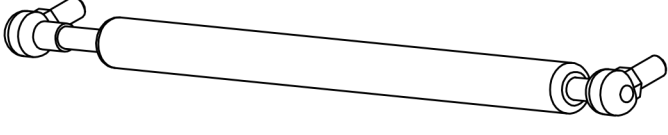
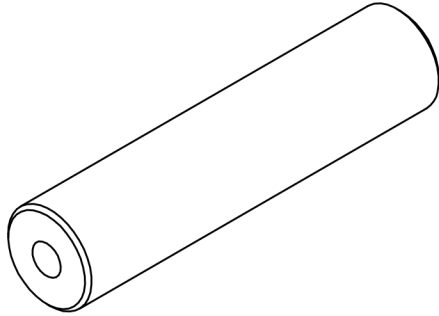
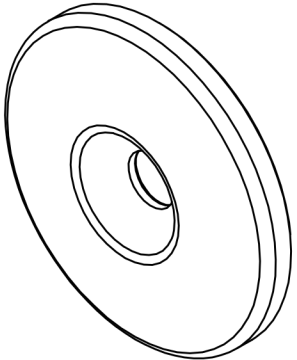
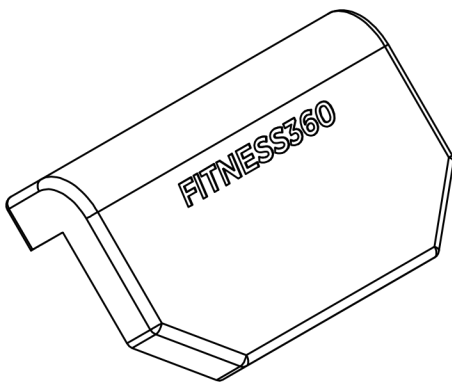
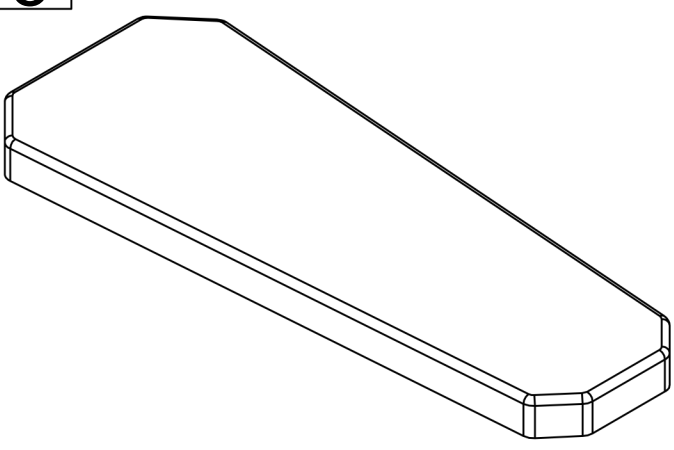
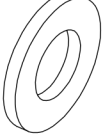
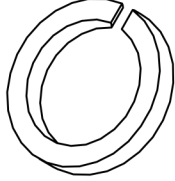
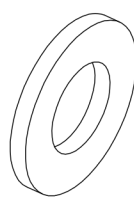
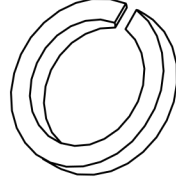
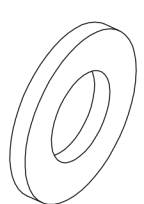
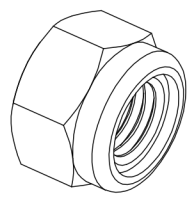
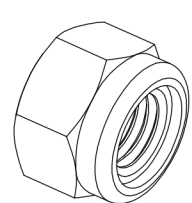
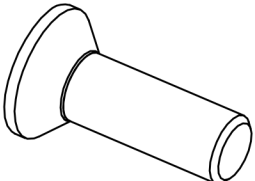
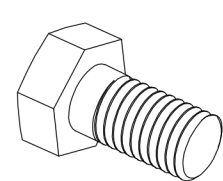
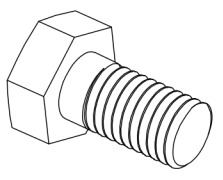
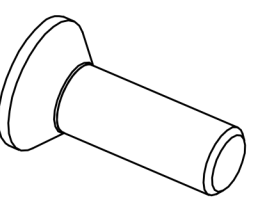
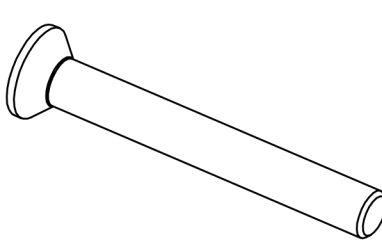
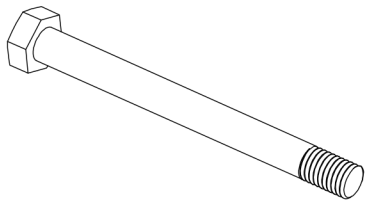
<p>1</p>  <p>1 PC</p>	<p>2</p>  <p>1 PC</p>	<p>3</p>  <p>1 PC</p>	<p>4</p>  <p>1 PC</p>
<p>5</p>  <p>1 PC</p>	<p>6</p>  <p>1 PC</p>	<p>7</p>  <p>1 PC</p>	<p>8</p>  <p>2 PC</p>
<p>9</p>  <p>2 PC</p>	<p>10</p>  <p>2 PC</p>	<p>11</p>  <p>1 PC</p>	<p>12</p>  <p>1 PC</p>
<p>13</p>  <p>2 PC</p>	<p>14</p>  <p>1 PC</p>	<p>15</p>  <p>1 PC</p>	<p>16</p> <p>M8 Washer</p>  <p>18 PC</p>
<p>17</p> <p>M8 Spring washer</p>  <p>18 PC</p>	<p>18</p> <p>M10 Washer</p>  <p>16 PC</p>	<p>19</p> <p>M10 Spring washer</p>  <p>2 PC</p>	<p>20</p> <p>M12 Washer</p>  <p>4 PC</p>
<p>21</p> <p>M10 Nut</p>  <p>8 PC</p>	<p>22</p> <p>M12 Nut</p>  <p>2 PC</p>	<p>23</p> <p>M8*25 Bolt</p>  <p>2 PC</p>	<p>24</p> <p>M8*30 Bolt</p>  <p>18 PC</p>
<p>25</p> <p>M10*25 Bolt</p>  <p>4 PC</p>	<p>26</p> <p>M10*25 Bolt</p>  <p>4 PC</p>	<p>27</p> <p>M10*75 Bolt</p>  <p>2 PC</p>	<p>28</p> <p>M10*75 Bolt</p>  <p>2 PC</p>

PART LIST

29

M10*100 Bolt

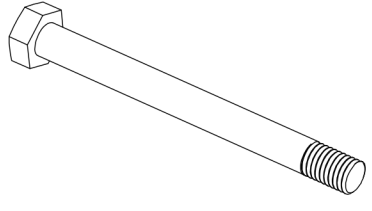

2 PC

30



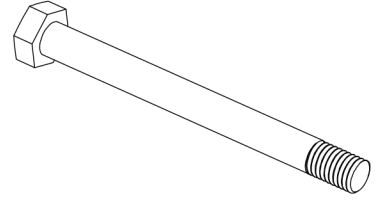



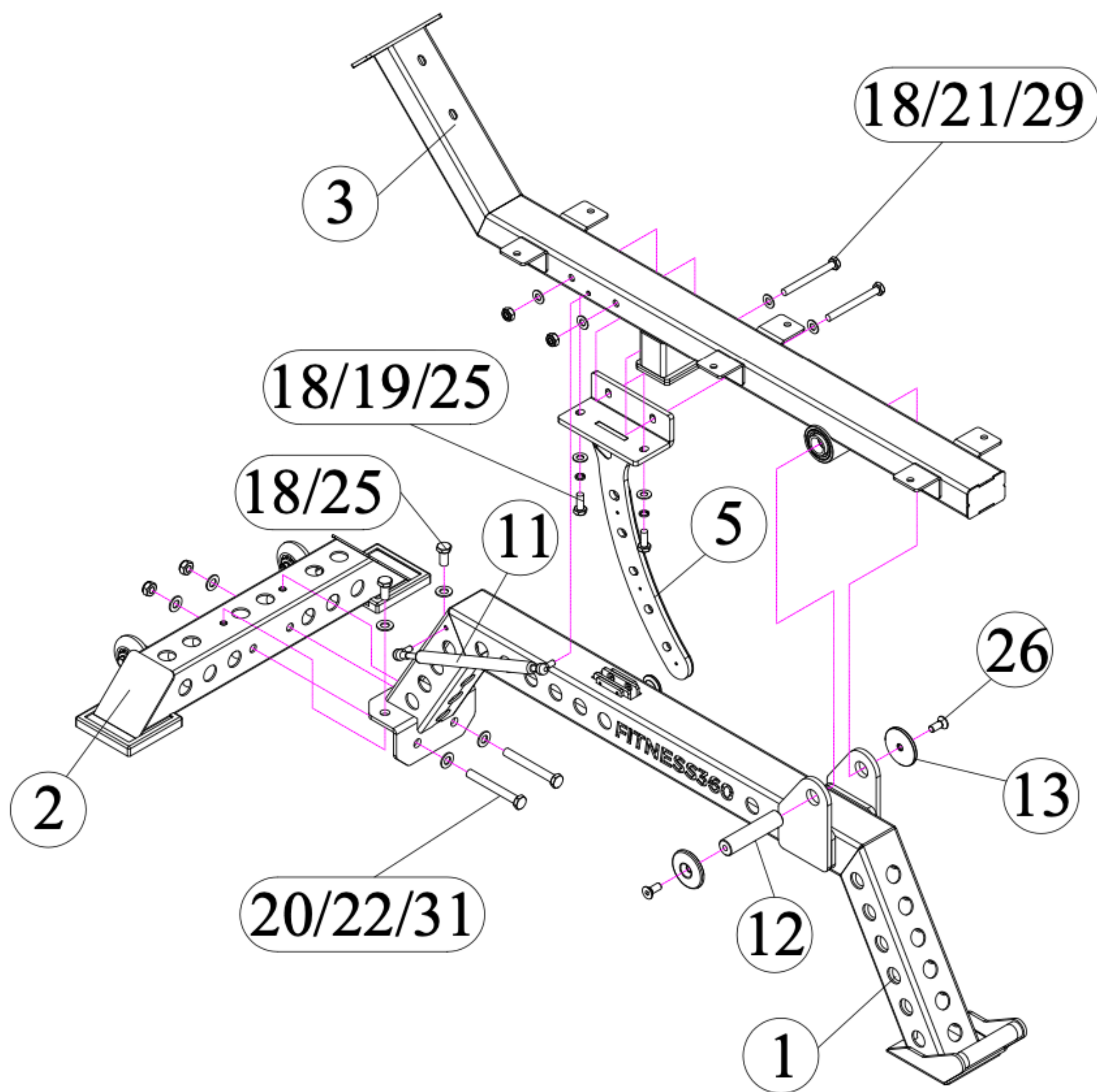

M12*100 Bolt

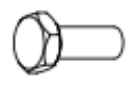

2 PC

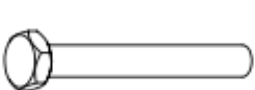

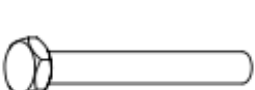
STEP 1



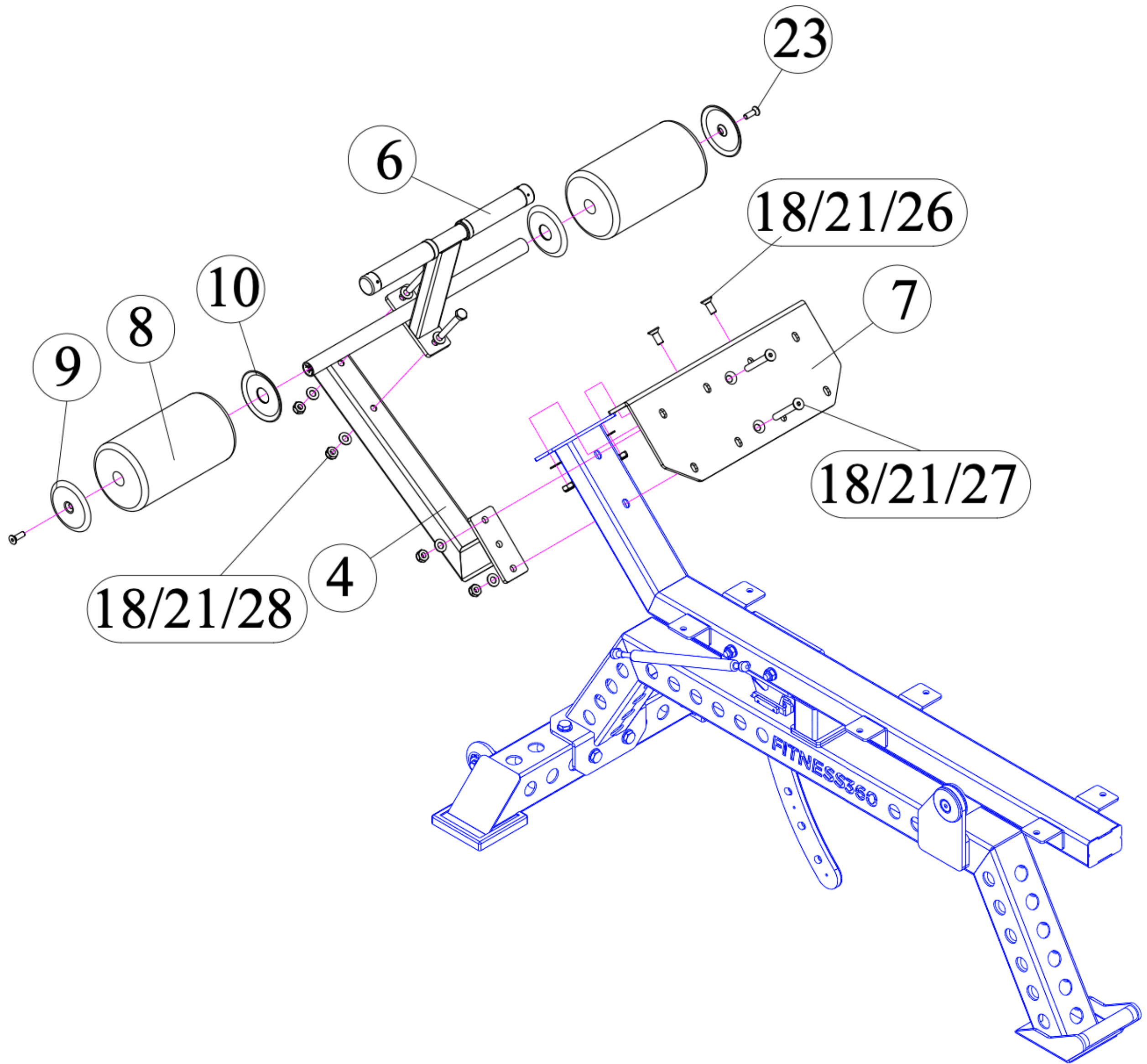

25		M10*25	Qty:4	18		10	Qty:8
26		M10*25	Qty:2	19		10	Qty:2
29		M10*100	Qty:2	20		12	Qty:4
30		M12*100	Qty:2	21		M10	Qty:2
				22		M12	Qty:2

STEP 2

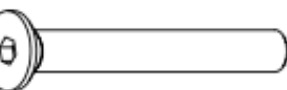
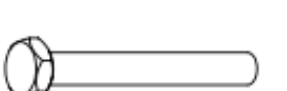



23		M8*25	Qty:2
26		M10*25	Qty:2
27		M10*75	Qty:2
28		M10*75	Qty:2

24		10	Qty:8
26		M10	Qty:6

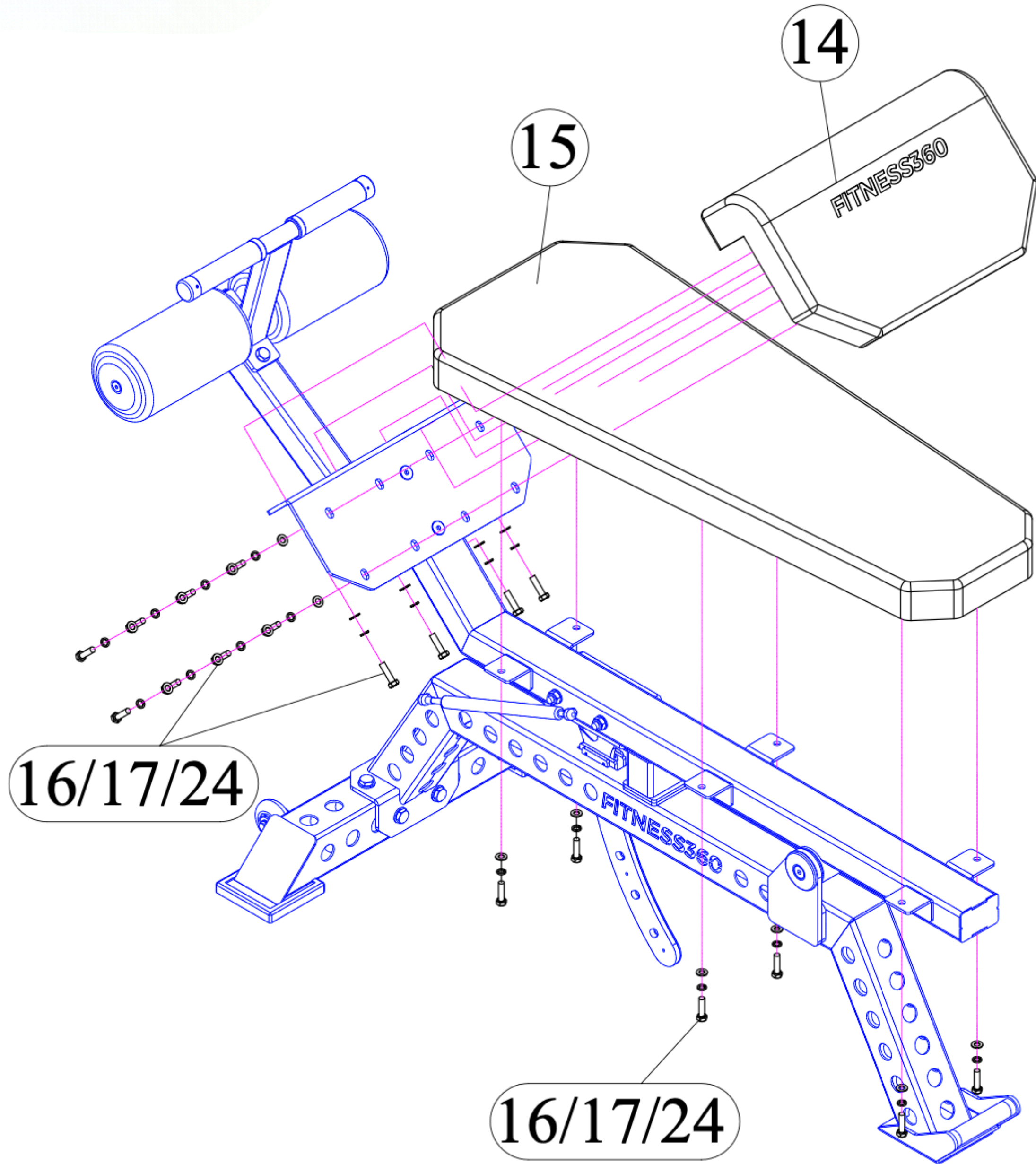
STEP 3

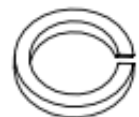
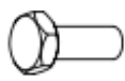

				16		8	Qty:18
24		M8*30	Qty:18	17		8	Qty:18